

COLONNE - CAPITELLI - PILASTRI, ANGOLARI
COLUMNS - CAPITALS & PILARS





COLONNE - CAPITELLI - PILASTRI, ANGOLARI
COLUMNS - CAPITALS & PILARS

COLONNA/PARASTA DORICA

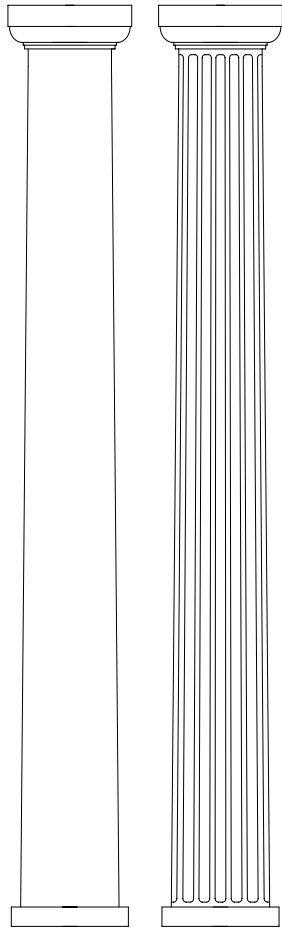

COLONNA/PARASTA TOSCANA

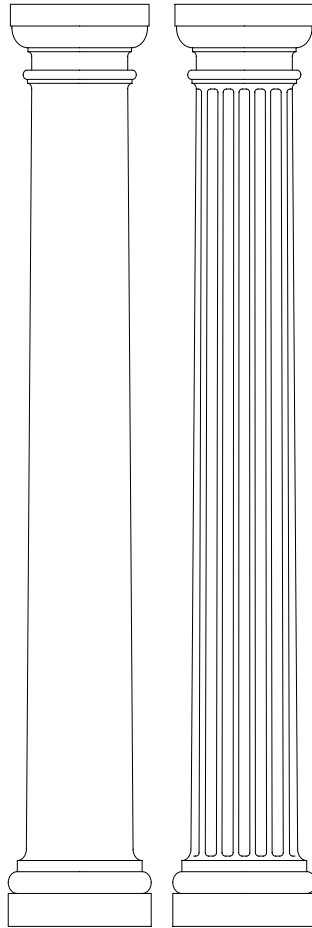

COLONNA/PARASTA IONICA

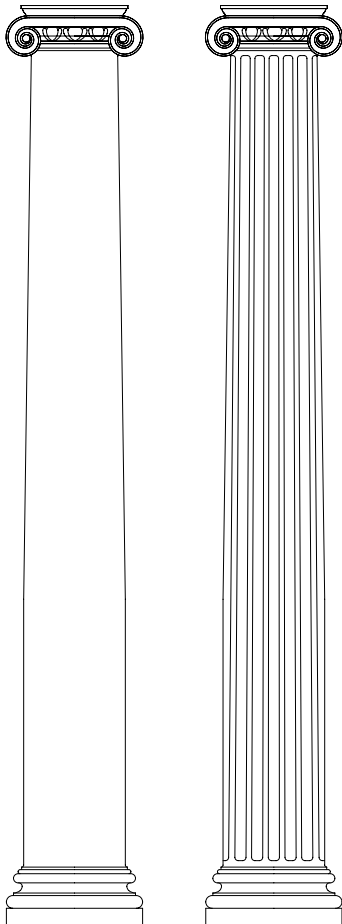

COLONNA/PARASTA CORINZIA

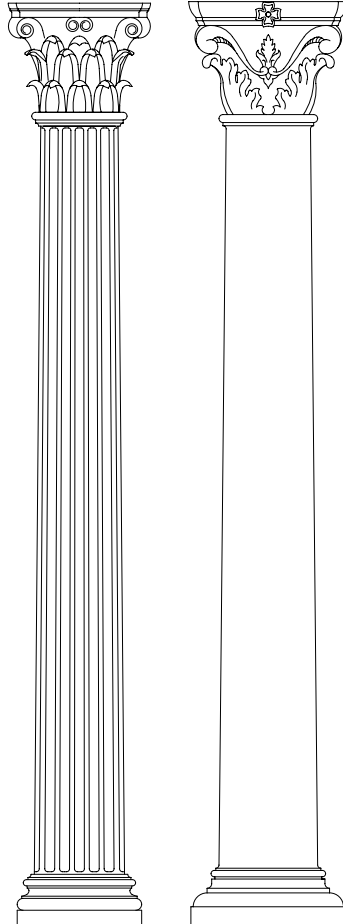

N.B. 1 the shape of the columns may differs from the one drawn above without any price difference if diameter ad high remain the same (for this You may need to consult our technical office).

N.B. 2 columns are sold in separate pieces: base - shaft (1 piece until 250 cm. max) - capitel to be assebled during installation at Customer charge.

COLONNE DORICHE

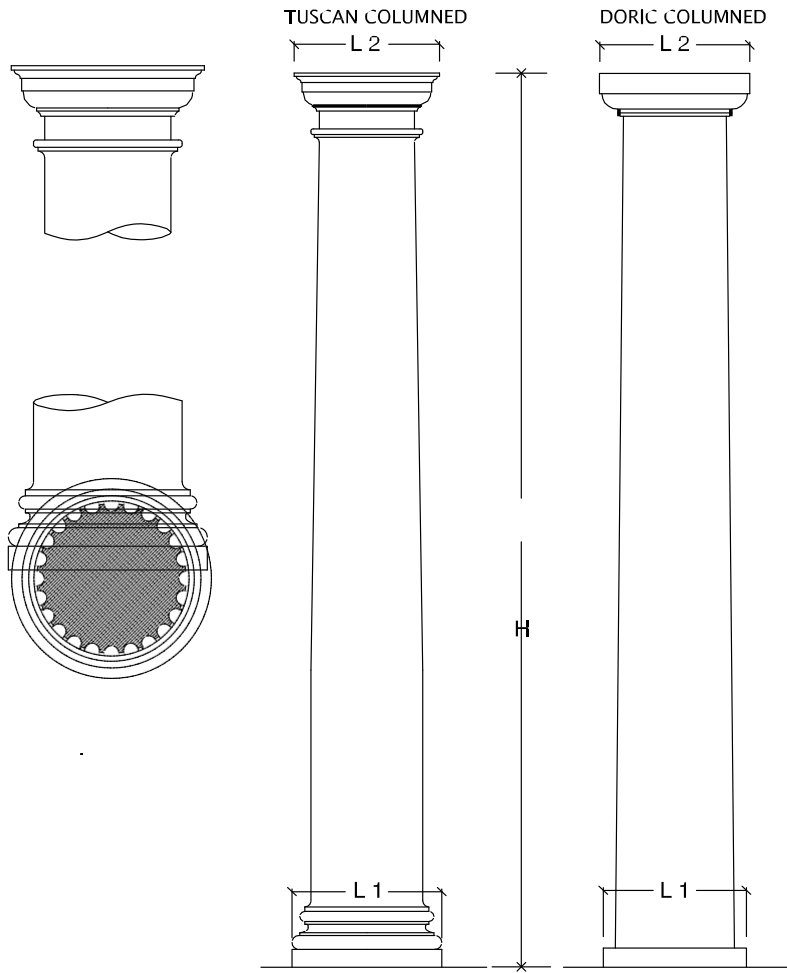

COLONNE STILE DORICO - TUSCANICO / COLUMN IN DORIC - TUSCAN STYLE

Descrizione / Description	Giallo Dorato	Bianco Avorio	Bianco Avorio Extra*	Grigio Argento Grigio Alpini	Pietra Serena	Grigio Perla Fumo di Londra	Giallo Tornabuoni	Rosso Etrusco R. Pompeiano	Terra di Siena Giallo Egizio
Colonne H 200/220 diametro 20 cm / Columns h 200/220 diam. 20cm									
Colonne H 220/230 diametro 25cm / Columns h 220/230 diam. 25 cm									
Colonne H 250 diametro 30 cm / Columns h 250 diam. 30 cm									
Colonne H 300 diametro 35 cm / Columns h 300 diam. 35 cm									

SUPPLEMENTO LAVORAZIONI / INCREASE FOR EXTRA WORKINGS

Descrizione / Description	TAGLIO A META' E SVUOTAMENTO HALF CUT AND CORED	SCANALATURE GROOVES
Colonne H 200/220 diametro 20 cm / Columns h 200/220 diam. 20cm		
Colonne H 220/230 diametro 25cm / Columns h 220/230 diam. 25 cm		
Colonne H 250 diametro 30 cm / Columns h 250 diam. 30 cm		
Colonne H 300 diametro 35 cm / Columns h 300 diam. 35 cm		

N.B. 1 la sagoma delle colonne può differire da quelle sopra presentata senza variazioni di prezzo ferme restando le dimensioni (diametro e altezza.), e la possibilità di esecuzione.

N.B. 2 le colonne vengono vendute in pezzi separati base – fusto (fino a 200 / 250 cm. in 1 unico pezzo, oltre in più pezzi) e capitello, da assemblare in fase di posa in opera a carico del cliente

* Bianco Avorio Extra: se disponibile / if available

COLONNE - CAPITELLI - PILASTRI, ANGOLARI
COLUMNS - CAPITALS & PILARS



COLONNE IONICHE

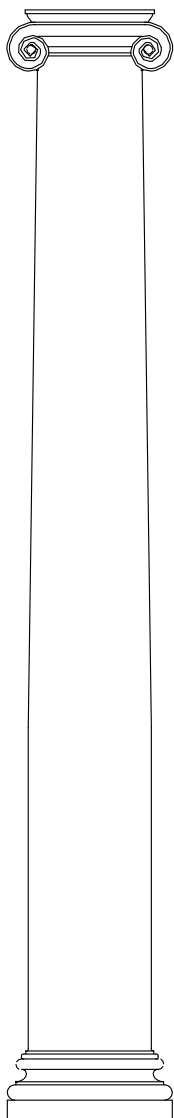
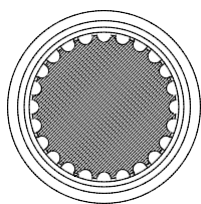
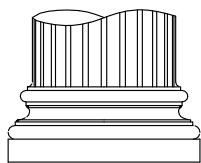
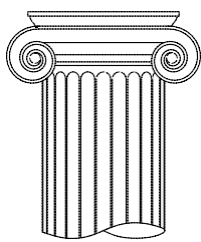

COLONNE IN STILE IONICO / COLUMNS IN IONIC STYLE

Descrizione / Description	Giallo Dorato	Bianco Avorio	Bianco Avorio Extra*	Grigio Argento Grigio Alpini	Pietra Serena	Grigio Perla Fumo di Londra	Giallo Tornabuoni	Rosso Etrusco R. Pompeiano	Terra di Siena Giallo Egizio
Colonne H 200/220 diametro 20 cm / Columns h 200/220 diam. 20cm									
Colonne H 220/230 diametro 25cm / Columns h 220/230 diam. 25 cm									
Colonne H 250 diametro 30 cm / Columns h 250 diam. 30 cm									
Colonne H 300 diametro 35 cm / Columns h 300 diam. 35 cm									

* Bianco Avorio Extra: se disponibile / if available

SUPPLEMENTO LAVORAZIONI / INCREASE FOR EXTRA WORKINGS

Descrizione / Description	TAGLIO A META' E SVUOTAMENTO HALF CUT AND CORED	SCANALATURE GROOVES
Colonne H 200/220 diametro 20 cm / Columns h 200/220 diam. 20cm		
Colonne H 220/230 diametro 25cm / Columns h 220/230 diam. 25 cm		
Colonne H 250 diametro 30 cm / Columns h 250 diam. 30 cm		
Colonne H 300 diametro 35 cm / Columns h 300 diam. 35 cm		

N.B. 1 la sagoma delle colonne può differire da quelle sopra presentata senza variazioni di prezzo ferme restando le dimensioni (diametro e altezza), e la possibilità di esecuzione.

N.B. 2 le colonne vengono vendute in pezzi separati base - fusto (fino a 200 / 250 cm. in 1 unico pezzo, oltre in più pezzi) e capitello, da assemblare in fase di posa in opera a carico del cliente



COLONNE CORINZIE

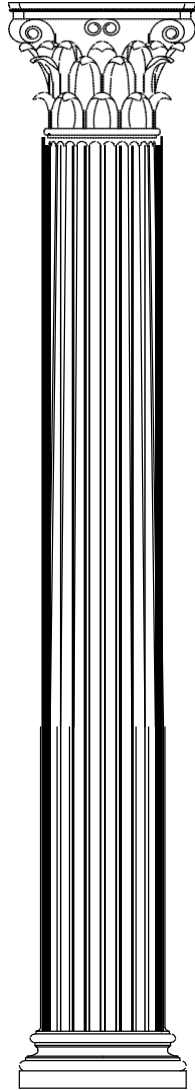
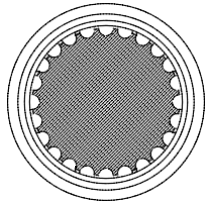
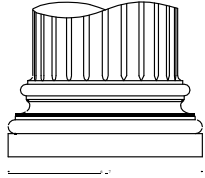
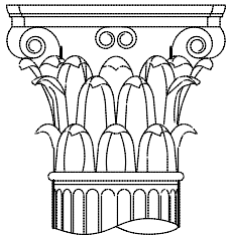

COLONNE STILE CORINZIO / COLUMNS IN CORINTHIAN STYLE

Descrizione / Description	Giallo Dorato	Bianco Avorio	Bianco Avorio Extra*	Grigio Argento Grigio Alpini	Pietra Serena	Grigio Perla Fumo di Londra	Giallo Tornabuoni	Rosso Etrusco R. Pompeiano	Terra di Siena Giallo Egizio
---------------------------	---------------	---------------	----------------------	---------------------------------	---------------	--------------------------------	----------------------	-------------------------------	---------------------------------

Colonne H 200/220 diametro 20 cm /
Columns h 200/220 diam. 20cm

Colonne H 220/230 diametro 25cm /
Columns h 220/230 diam. 25 cm

Colonne H 250 diametro 30 cm /
Columns h 250 diam. 30 cm

Colonne H 300 diametro 35 cm /
Columns h 300 diam. 35 cm

* Bianco Avorio Extra: se disponibile / if available

SUPPLEMENTO LAVORAZIONI / INCREASE FOR EXTRA WORKINGS

Descrizione	TAGLIO A META' E SVUOTAMENTO HALF CUT AND CORED	SCANALATURE GROOVES
Colonne H 200/220 diametro 20 cm / Columns h 200/220 diam. 20cm		
Colonne H 220/230 diametro 25cm / Columns h 220/230 diam. 25 cm		
Colonne H 250 diametro 30 cm / Columns h 250 diam. 30 cm		
Colonne H 300 diametro 35 cm / Columns h 300 diam. 35 cm		

N.B. 1 la sagoma delle colonne può differire da quelle sopra presentata senza variazioni di prezzo ferme restando le dimensioni (diametro e altezza.), e la possibilità di esecuzione.

N.B. 2 le colonne vengono vendute in pezzi separati base – fusto (fino a 200 / 250 cm. in 1 unico pezzo, oltre in più pezzi) e capitello, da assemblare in fase di posa in opera

a carico del cliente

ESEMPI APPLICAZIONI COLONNE / EXAMPLE APPLICATION COLUMNS



PIETRA
AUTENTICA

COLONNE - CAPITELLI - PILASTRI, ANGOLARI
COLUMNS - CAPITALS & PILARS

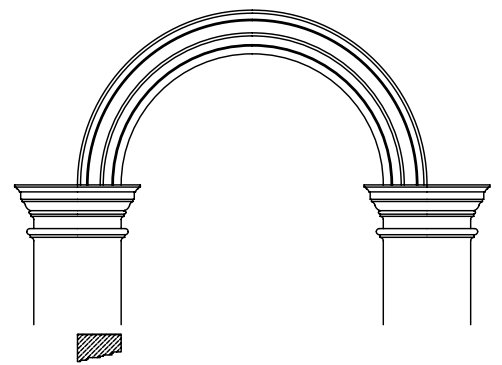
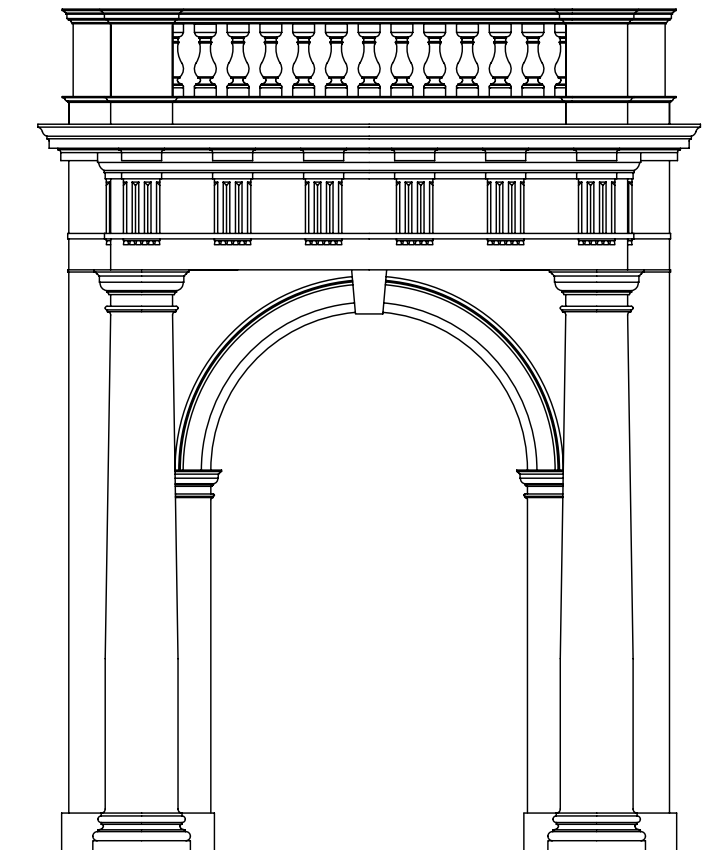
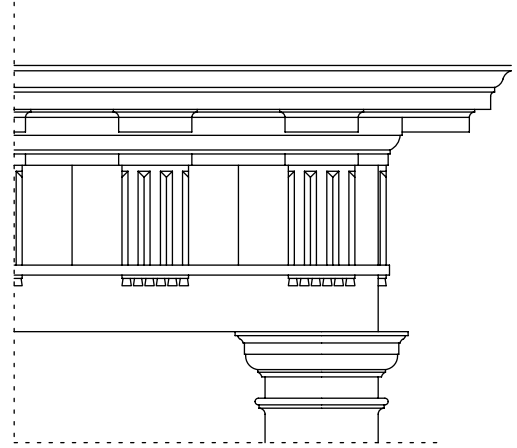
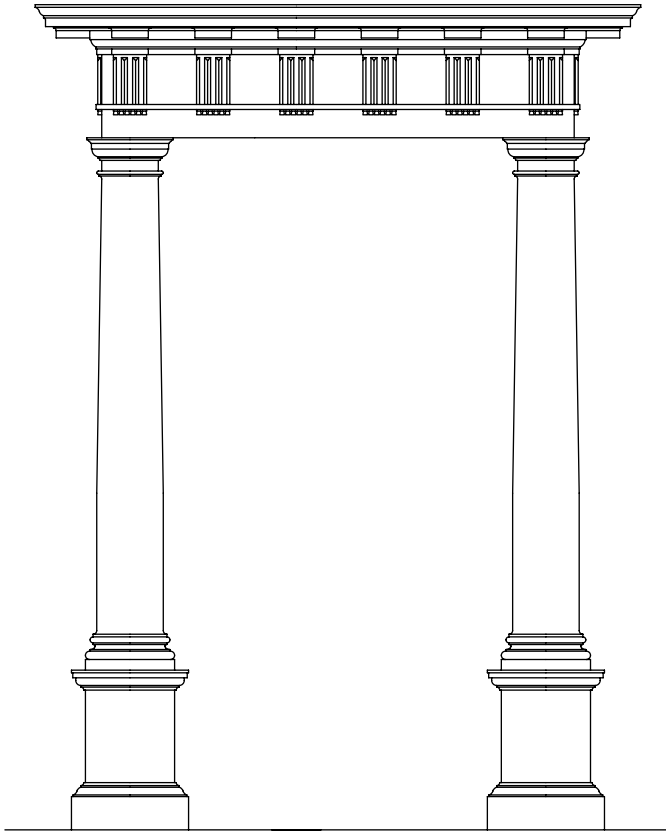



C

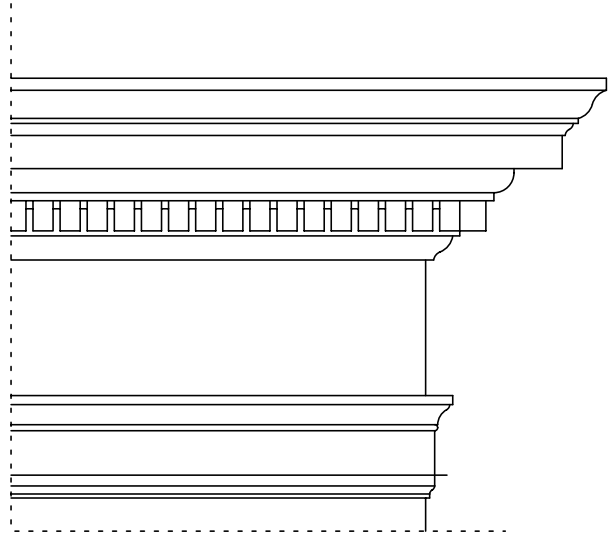
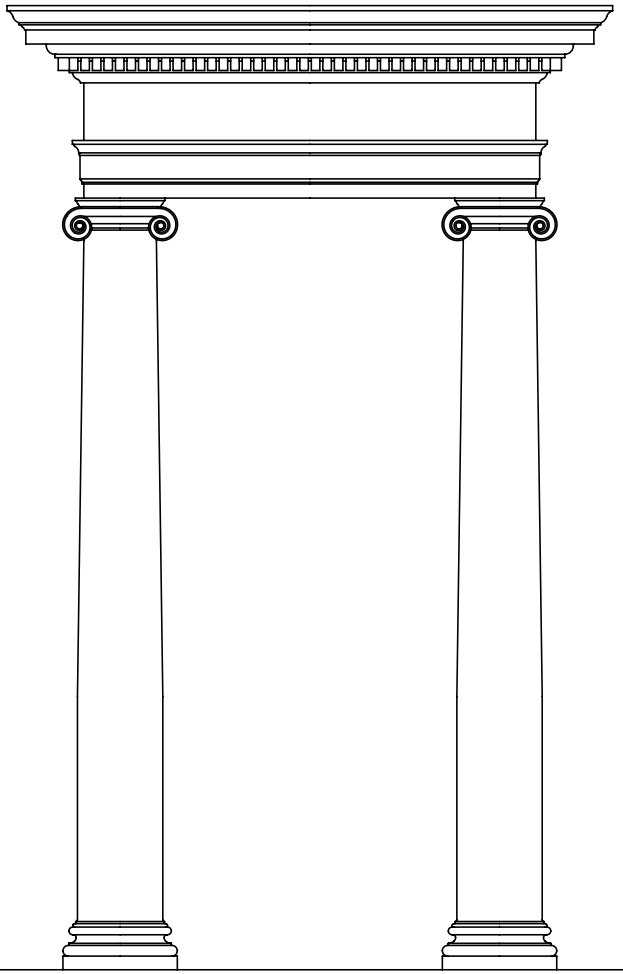

COLONNE - CAPITELLI - PILASTRI, ANGOLARI
COLUMNS - CAPITALS & PILARS



PIETRA
AUTENTICA

COLONNE - CAPITELLI - PILASTRI, ANGOLARI
COLUMNS - CAPITALS & PILARS

ESEMPI APPLICAZIONI COLONNE / EXAMPLE APPLICATION COLUMNS

D

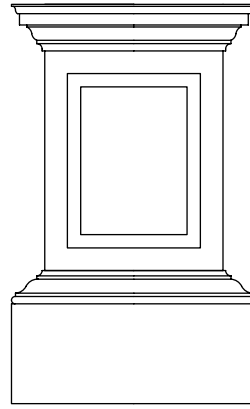
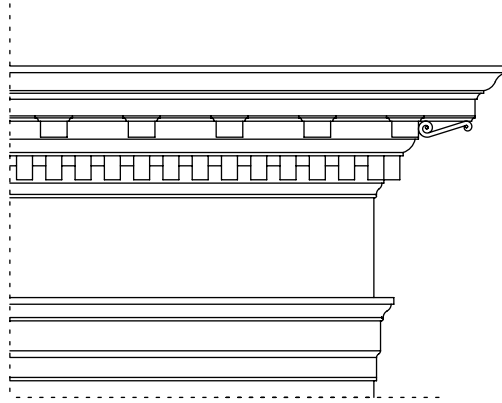
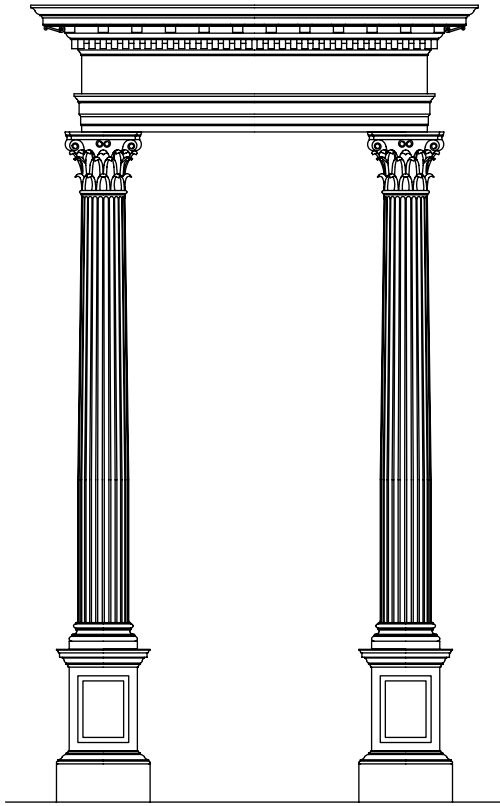

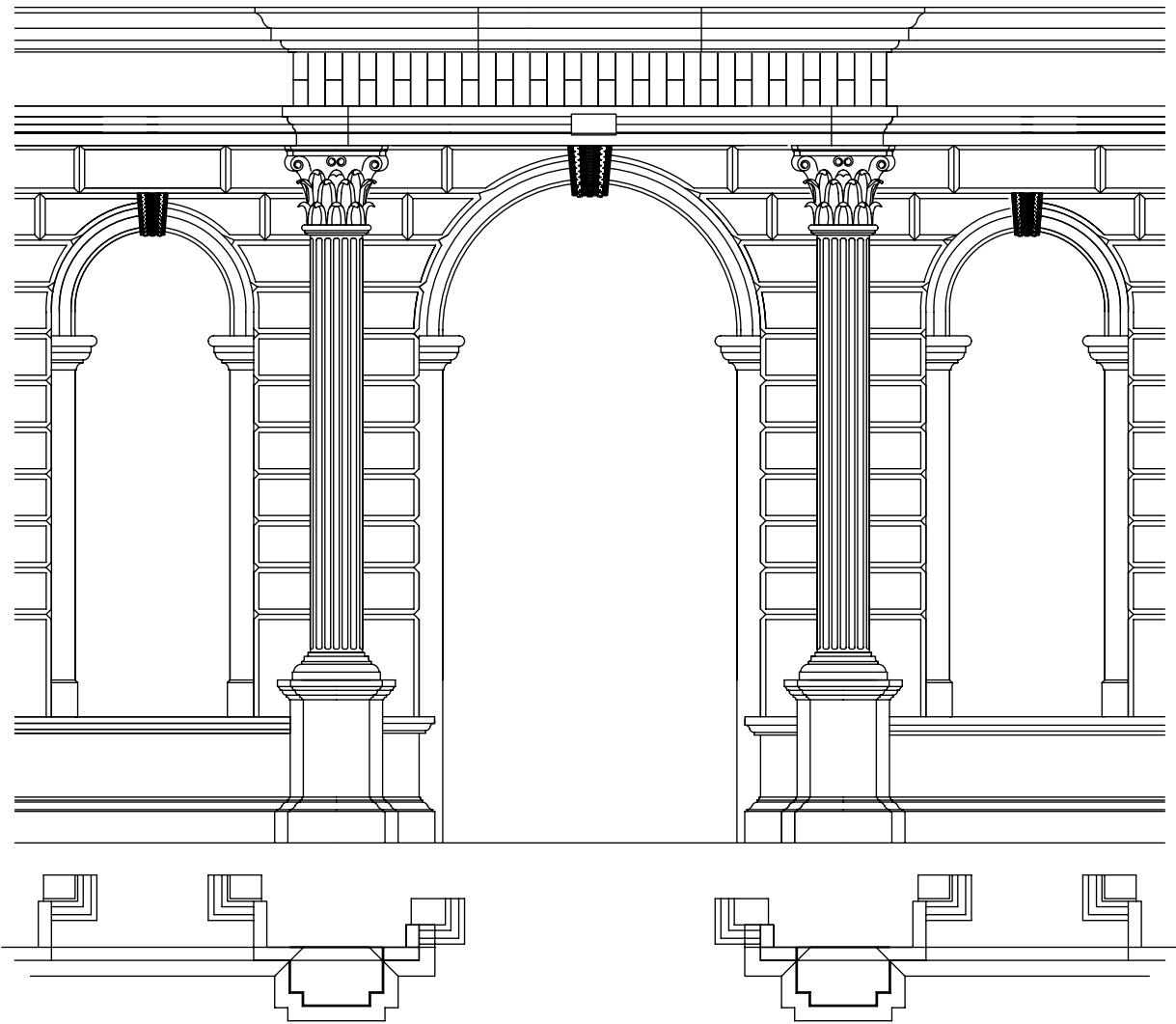

COLONNE - CAPITELLI - PILASTRI, ANGOLARI
COLUMNS - CAPITALS & PILARS

CAPITELLI E PILASTRI / CAPITALS PILARS



PIETRA
AUTENTICA

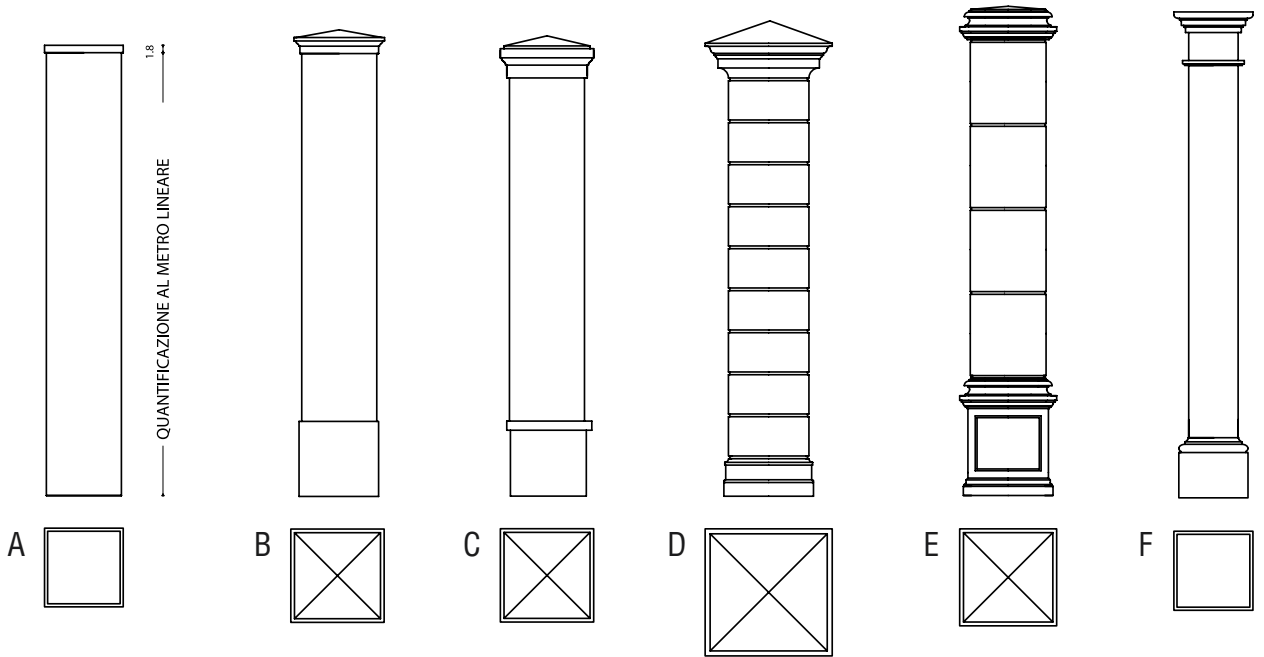

COLONNE - CAPITELLI - PILASTRI, ANGOLARI
COLUMNS - CAPITALS & PILARS

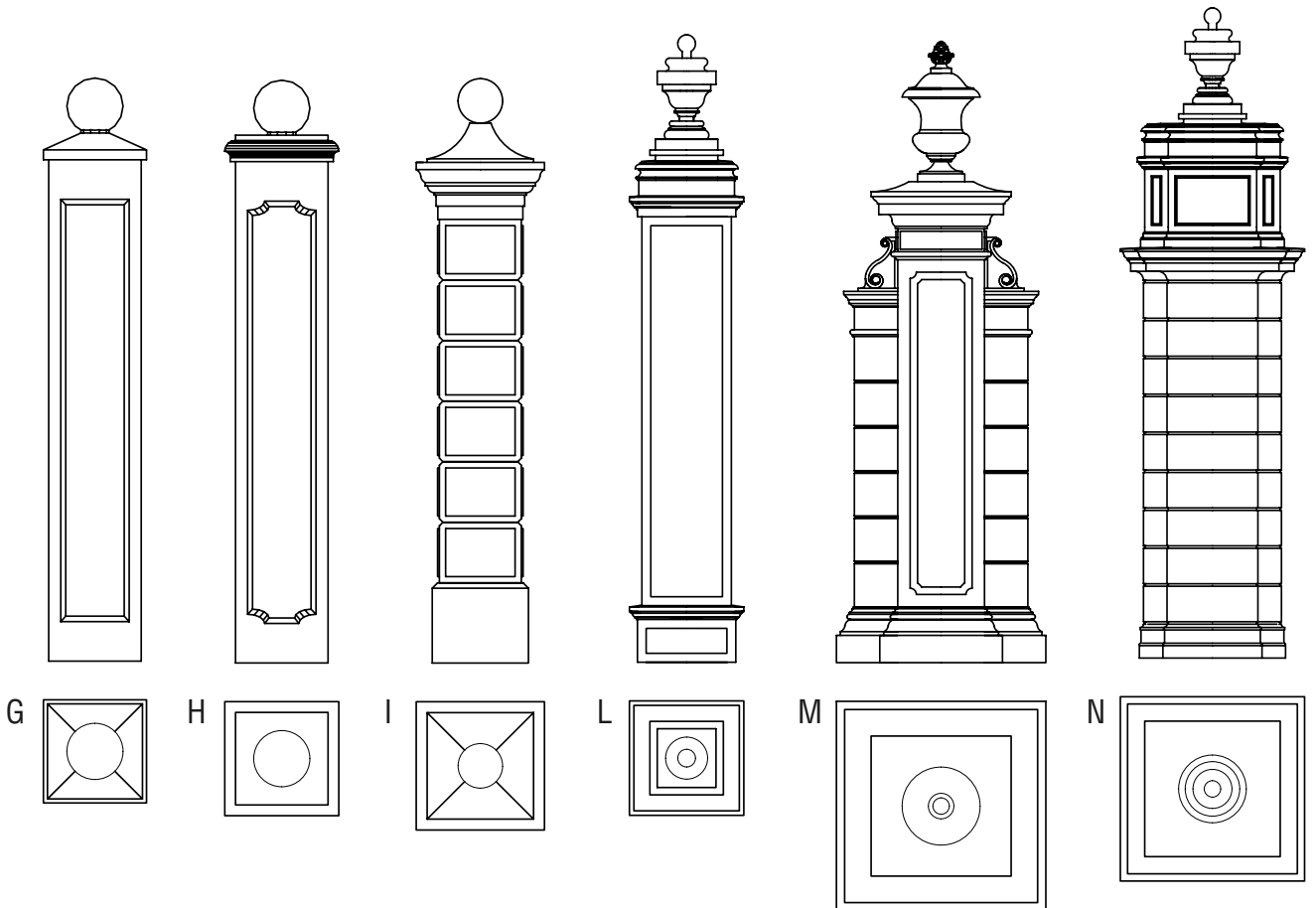

Tutte le misure possono essere modificate
Every measure can be changed

Trattamento ed installazione non inclusi
Treatment and installation not included



ANGOLARI

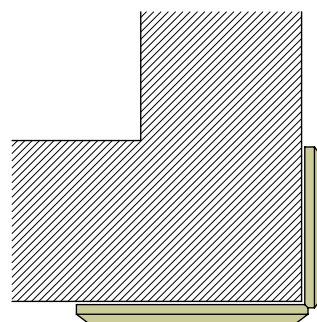
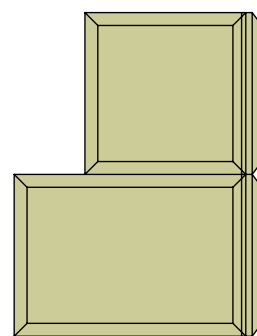
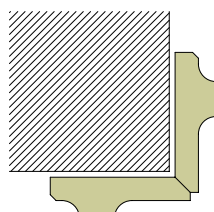
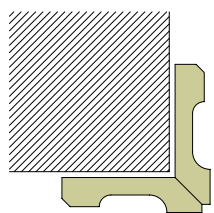
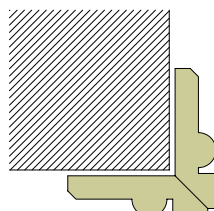
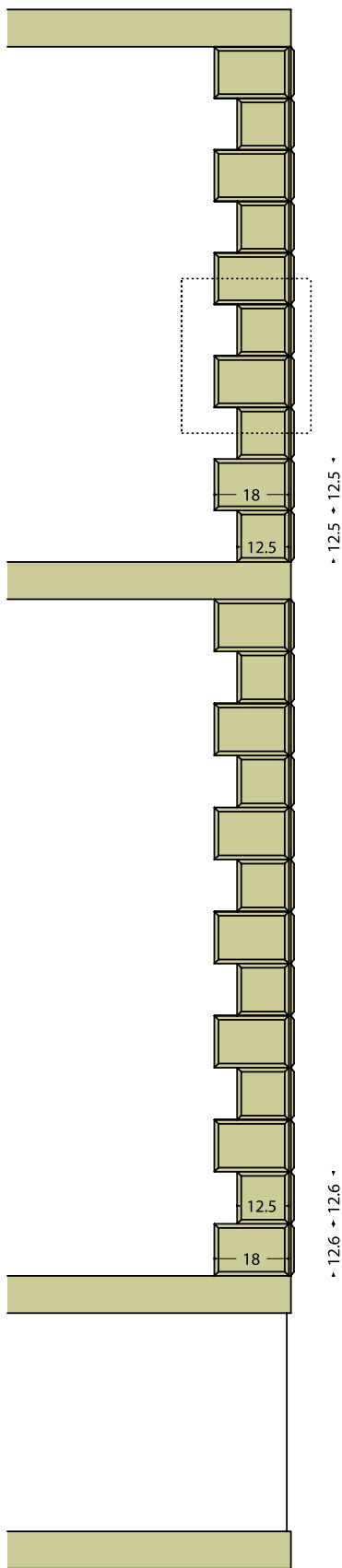

ANGOLARI MURATURA

ANGOLARI MURATURA

COLONNE - CAPITELLI - PILASTRI, ANGOLARI
 COLUMNS - CAPITALS & PILARS